



JUPITER AVIONICS
CORPORATION

JA72-310

**Glove Box with Dual USB Charger
and Audio Jack - 10 Dzus**



Installation and Operating Manual

Rev. A

**Jupiter Avionics Corporation
1959 Kirschner Road
Kelowna BC
Canada V1Y 4N7
Tel: +1 778 478 2232
Toll-Free: 1 855 478 2232
www.jupiteravionics.com**



Copyright 2016 Jupiter Avionics Corp.

All rights reserved

Jupiter Avionics Corporation (JAC) permits a single copy of this manual to be printed or downloaded for the express use of an installing agency. Any such electronic or printed copy of this manual must contain the complete text of this copyright notice. Any unauthorized commercial distribution of this manual is strictly prohibited. Except as described above, no part of this manual may be reproduced, copied, transmitted, disseminated, downloaded, or stored in any storage medium for any purpose without the express prior written consent of JAC.

IMPORTANT:

Information in this document is subject to change without notice.

To confirm the current revision status of this manual, visit the JAC website:

www.jupiteravionics.com

RECORD OF REVISIONS			
Revision	Rev Date	Description	ECR
A	Jan 2016	Initial release, Serial number 1001 and higher.	3958



Prepared: MPB	Checked: 	Approved: 
------------------	---	--



Table of Contents

SECTION 1 - DESCRIPTION	1
1.1 System Overview.....	1
1.2 Features Overview.....	1
1.3 Inputs and Outputs	1
1.3.1 Inputs	1
1.3.2 Bi-Directional Ports	1
1.3.3 Output	1
1.4 Specifications.....	1
1.4.1 Electrical Specifications.....	1
1.4.2 Mechanical Specifications	2
1.4.3 Flammability of Materials	2
SECTION 2 – INSTALLATION	3
2.1 Introduction	3
2.2 Continued Airworthiness.....	3
2.3 Unpacking and Inspecting Equipment.....	3
2.3.1 Warranty	3
2.4 Installation Procedures	3
2.4.1 Installation Limitations	3
2.4.2 Cabling and Wiring	3
2.4.3 Mechanical Installation	4
2.4.6 Post Installation Checks	4
2.5 Installation Kit	4
2.5.1 Recommended Crimp tools	4
2.6 Installation Drawings.....	4
SECTION 3 – OPERATION	5
3.1 Introduction	5
3.2 Front Panel Connectors.....	5
3.2.1 Audio I/O	5
3.2.2 USB Power Output 5V/2.1A.....	5
3.3 Compatibility	5
Appendix A - Installation Drawings	A1
A1 Introduction	A1
A2 Installation Drawings.....	A1
Appendix B - Installation Documents	B1
B1 Airworthiness	B2
B2 Instructions for Continued Airworthiness.....	B2

JA72-310 Glove Box with Dual USB Charger and Audio Jack - 10 Dzus

SECTION 1 - DESCRIPTION

1.1 System Overview

The JA72-310 Glove Box with Dual USB Charger and Audio Jack - 10 Dzus allows the aircraft owner /operator to use an unused portion of the instrument panel for storage. The interior of the glove box has a black anodized finish to minimize scratches.

The JA72-310 uses a 10 Dzus high aperture.

1.2 Features Overview

Two USB 2.0 Type A receptacles are provided to supply 5 Vdc power up to 2.1 Amps each.

A 3.5mm stereo jack is also provided to enable music players to be connected to the aircraft's audio system.

1.3 Inputs and Outputs

Refer to the JA72-310 [connector map](#) for the mating connector designators and contact assignments for the input and bi-directional signals.

1.3.1 Inputs

Name	Qty	Type
D+ and D-	4	Charge sense
POWER INPUT	1	Power
SPARE	1	Spare

1.3.2 Bi-Directional Ports

Name	Qty	Type
AUDIO LEFT, AUDIO RIGHT	2	Audio I/O connector, audio
RESERVED	1	Audio I/O connector, reserved
AUDIO LEFT, AUDIO RIGHT	2	Main connector, audio
RESERVED	1	Main connector, reserved

1.3.3 Output

Name	Qty	Type
+5VDC	2	USB power output

1.4 Specifications

1.4.1 Electrical Specifications

Power Input

Primary nominal voltage	28.0 Vdc
Maximum voltage	32.2 Vdc
Minimum voltage	22.0 Vdc
Emergency voltage	18.0 Vdc
Power Input - Off	≤ 14 Vdc
Input current at 28 Vdc	≤ 1.4 A



1.4.1.1 +5V Output Performance

Output rated current	2.10 A
Output rated voltage	+5 Vdc ± 12 %
Ripple	≤ 280 mVrms
Short circuit	≥ 1 min

1.4.2 Mechanical Specifications

Height	3.75 in [95.3 mm] maximum
Behind panel depth (not including connectors)	5.71 in [145.0 mm] maximum
Width	5.75 in [146.1 mm] maximum
Weight	1.50 lb [0.68 kg] maximum
Enclosure:	5052-H32 aluminum; brushed texture and black anodized
Faceplate	6061-T651 Aluminum with flat black urethane paint; white legends
Connectors (3):	J1 Main One 9-pin D-Sub male, V5 locking J2/3 USB Two USB Type A Female J4 Audio i/o One 4 pole 3.5mm jack
Mounting	4 Dzus fasteners
Bonding	≤ 2.5 mΩ
Installation kit part number	INST-JA72

1.4.3 Flammability of Materials

The JA72-310 complies with the requirements of RTCA/DO-160G Sec 26.3.3 "Flammability", through equivalent flammability testing of materials and the Small Parts Exemption.

JA72-310 Glove Box with Dual USB Charger and Audio Jack - 10 Dzus

SECTION 2 – INSTALLATION

2.1 Introduction

This section contains unpacking and inspection procedures, installation information, and post-installation checks.

2.2 Continued Airworthiness

Maintenance of the JA72-310 is on condition only. Scheduled inspection and/or periodic maintenance of this unit is not required.

2.3 Unpacking and Inspecting Equipment

Unpack the equipment carefully. Check for shipping damage and report any problems to the relevant carrier. Confirm that the Authorized Release Certificate or Certificate of Conformance is included. Complete the on-line warranty card from the Jupiter Avionics Corporation (JAC) website – www.jupiteravionics.com/warranty.

2.3.1 Warranty

All products manufactured by JAC are warranted to be free of defects in workmanship or performance for 2 years from the date of installation by an approved JAC dealer or agency. This warranty covers the cost of all materials and labour to repair or replace the unit, but does not include the cost of transporting the defective unit to and from JAC or its designated warranty repair centre, or of removing and replacing the defective unit in the aircraft. This warranty does not cover failures due to abuse, misuse, accident, or unauthorized alteration or repairs.

THIS WARRANTY IS VOID IF THE PRODUCT IS NOT INSTALLED BY AN AUTHORIZED JAC DEALER. If the on-line warranty card is not completed, the product will be warranted from the date of manufacture.

Contact JAC for return authorization, and for any questions regarding this warranty and how it applies to your unit(s). JAC is the final arbiter concerning warranty issues.

2.4 Installation Procedures



CAUTION: The power input circuitry of the unit may be damaged if the installation does not conform to the wiring instructions in this manual.

2.4.1 Installation Limitations

Those installing the JA72, on or in a specific type or class of aircraft, must determine that the aircraft installation conditions meet standards. The JA72 may be installed only by following the applicable airworthiness requirements.

2.4.2 Cabling and Wiring

All wire shall be selected in accordance with the original aircraft manufacturer's maintenance instructions, or AC43.13-1B Change 1, Paragraphs 11-76 through 11-78. Unshielded wire types shall qualify to MIL-W-22759 as specified in AC43.13-1B Change 1, Paragraphs 11-85, 11-86, and listed in Table 11-11. For shielded wire applications, use Tefzel MIL-C-27500 shielded wire with tag ring or equivalent (for shield terminations) to make the most compact and easily terminated interconnect. Follow the Connector Map in Appendix A of this manual.

Note that this unit has a 'clamshell' hood that is installed after the wiring is complete.

Maintain wire segregation and route wiring in accordance with the original aircraft manufacturer's maintenance instructions.



Unless otherwise noted, all wiring shall be a minimum of 20 AWG. Refer to the Interconnect drawing for additional specifications.

2.4.3 Mechanical Installation

The JA72-310 can be mounted in any attitude and location with adequate space for the front panel and sufficient clearance for the connector and wiring harness. It requires no direct cooling.

2.4.6 Post Installation Checks

2.4.6.1 Voltage/Resistance checks.

Do not attach this unit until the following conditions are met:

- a) Check P1 pin **1** for +28 Vdc relative to ground.
- b) Check P1 pin **6** (power ground) for continuity to ground (less than 0.5 Ω).
- c) Check P1 pin **7** (chassis ground) for continuity to ground (less than 0.5 Ω).
- d) Check all pins for shorts to ground or adjacent pins.

2.4.6.2 Power on Checks.

Power up the aircraft's systems and confirm normal operation of all functions of the JA72. Refer to Section 3 (Operation) for specific operational details.

When all performance checks are satisfied, complete the necessary regulatory documentation before releasing the aircraft for service. Refer to [Appendix B](#).

2.5 Installation Kit

The kit required to install this unit is not included with the unit.

The installation kit (Part # INST-JA72) consists of the following:

<u>Quantity</u>	<u>Description</u>	<u>JAC Part #</u>
1	D-Sub 9-pin connector, hood and 9 crimp pins	CON-3420-0009
1	JA72 Assembly Notes, Installation Kit	DOC-INST-JA72

2.5.1 Recommended Crimp tools

Standard D-Sub Crimp Tool Chart			
Tool Type	Hand crimping tool	Positioner	Insertion/extractor tool
POSITRONIC	9507-0-0-0	9502-5-0-0	4711-2-0-0
DANIELS	AFM 8	K13-1	91067-2
MIL-SPEC	M22520/2-01	M22520/2-08	M81969/1-02

2.6 Installation Drawings

The drawings and documents required for Installation can be found in [Appendix A](#) of this manual.



SECTION 3 – OPERATION

3.1 Introduction

This section contains the operating instructions for the JA72-310.

The JA72-310 provides a useful storage space with the added benefits of storing and charging a phone or other device, and connecting a music player or other audio input to the aircraft audio system.

The JA72-310 uses a 10 Dzus high panel height.

3.2 Front Panel Connectors

The JA72-310 has two front panel USB Power output connectors, and an Audio Input/Output jack

3.2.1 Audio I/O

The Audio I/O jack provides a stereo audio input or output when the interconnect is wired to appropriate audio equipment. It accepts a 3 pole 3.5mm stereo plug with a slim diameter connector housing.



Audio I/O

USB Power Output

3.2.2 USB Power Output 5V/2.1A

The Power Outputs are USB Type A connectors.

These connectors are provided to supply 5 Vdc up to 2.1 Amps each for charging cell phones and similar devices.



Note: These ports are not designed to be used for data transfer.

3.3 Compatibility



CAUTION: Attempting to connect an incompatible plug or device could damage the JA72, the attached device, or both.

If in doubt regarding compatibility of a specific item, contact Jupiter Avionics (www.jupiteravionics.com).



Installation and Operating Manual

Appendix A - Installation Drawings

A1 Introduction

The drawings necessary for installation and troubleshooting of the JA72-310 Glove Box with Dual USB Charger and Audio Jack - 10 Dzus are in this Appendix, as listed below.

A2 Installation Drawings

DOCUMENT	Rev
JA72-310 Connector Map	A
JA72-310 Interconnect	A
JA72-310 Mechanical Installation	A

Main Connector

P1

9 PIN FEMALE DMIN
MATING CONNECTOR

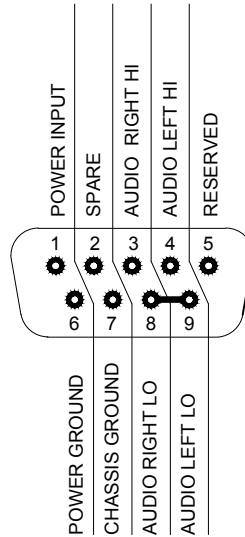

VIEW IS FROM REAR OF MATING CONNECTOR

USB Connector

P2 & P3

USB TYPE A MALE
MATING CONNECTOR

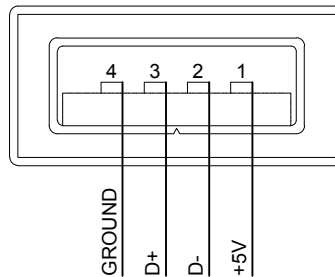

View is from front of mating connector

Audio I/O Connector

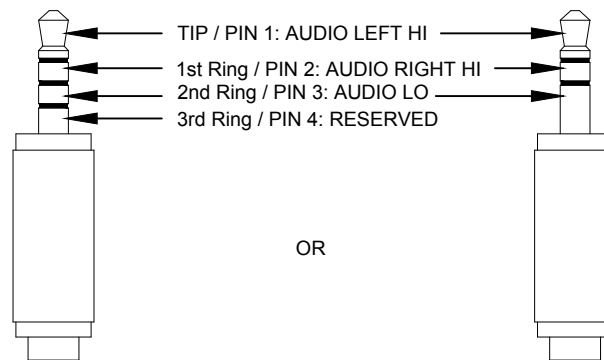

P4

3 POLE OR 4 POLE MALE 3.5mm
MATING CONNECTOR



View is from side of mating connector



View is from side of mating connector

PREPARED	TAT			
CHECKED				
APPROVED		NCAGE CODE L00N3	PART NO. JA72-310	SHEET 1/1
CONFIDENTIAL & PROPRIETARY TO JUPITER AVIONICS CORP.		DOC NO. JA72-310 Connector Map Rev A.dwg		

JA72-310 INTERCONNECT WIRING NOTES

NOTES

1. ALL WIRE SIZE SHOULD BE 24 AWG MIN UNLESS OTHERWISE SPECIFIED. UNSHIELDED WIRE SHOULD BE SELECTED PER FAA AC43.13-1B CHANGE 1 PARA 11-76 TO 11-78. WIRE TYPES SHOULD BE IN ACCORDANCE WITH MIL-W-22759 AS DESCRIBED IN FAA AC43.13-1B CHANGE 1 PARA 11-85 AND 11-86 AND LISTED IN TABLE 11-11 OR 11-12. ALL SHIELDED CABLE SHOULD BE IN ACCORDANCE WITH MIL-DTL-27500 (REVISION H OR LATER).
2. CONNECTION TO AIRFRAME GROUND SHOULD BE MADE WITH 20 AWG WIRE. LENGTH NOT TO EXCEED 3 FT (0.91 M).
3. CABLE SHIELDS AT THE JA72-310 CONNECTOR PINS MAY BE TERMINATED TO AIRFRAME GROUND USING A TAG RING P/N: MS27741-5 OR EQUIVALENT.
4. AUDIO LO's ARE CONNECTED TOGETHER INTERNALLY.
5. CABLE LENGTH NOT TO EXCEED 6 FT (1.82 M).

PREPARED	TAT			
CHECKED				
APPROVED		Glove Box with Dual USB Charger and Audio Jack 10 Dzus		
CONFIDENTIAL & PROPRIETARY TO JUPITER AVIONICS CORP.		NCAGE CODE L00N3	PART NO. JA72-310	DOC NO. JA72-310 Interconnect Rev A.dwg

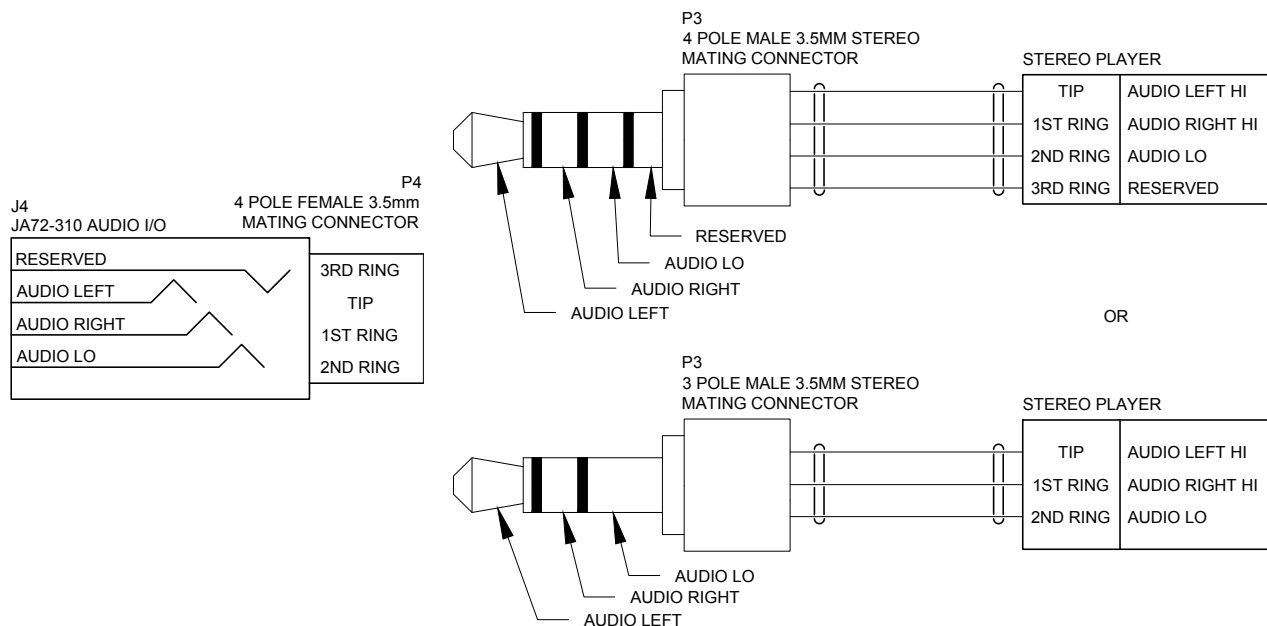
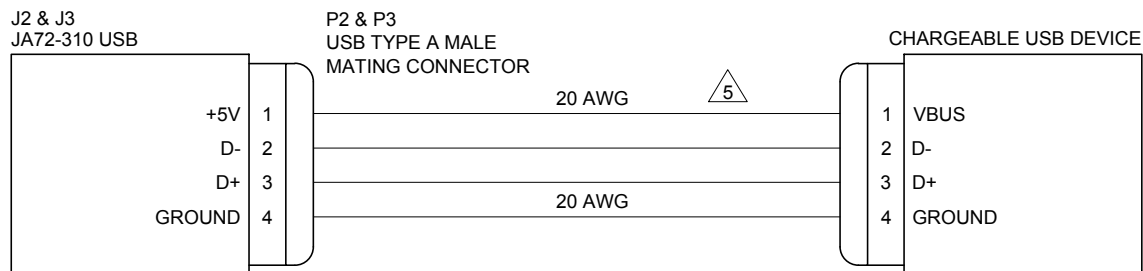
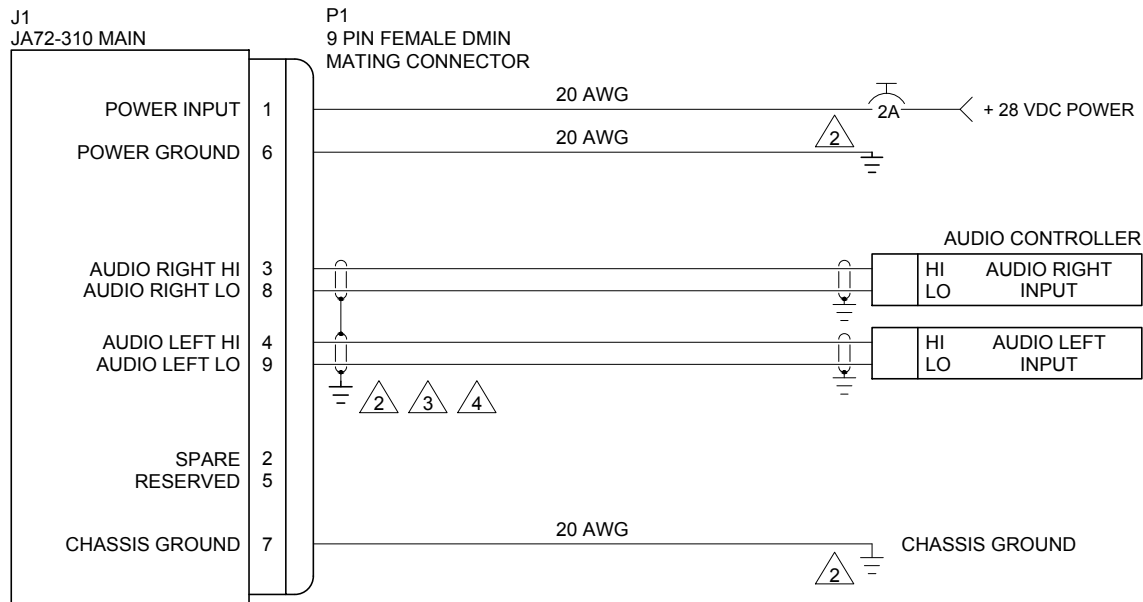

PREPARED	TAT			
CHECKED				
APPROVED		NCAGE CODE L00N3	PART NO. JA72-310	SHEET 2/2
CONFIDENTIAL & PROPRIETARY TO JUPITER AVIONICS CORP.		DOC NO. JA72-310 Interconnect Rev A.dwg		

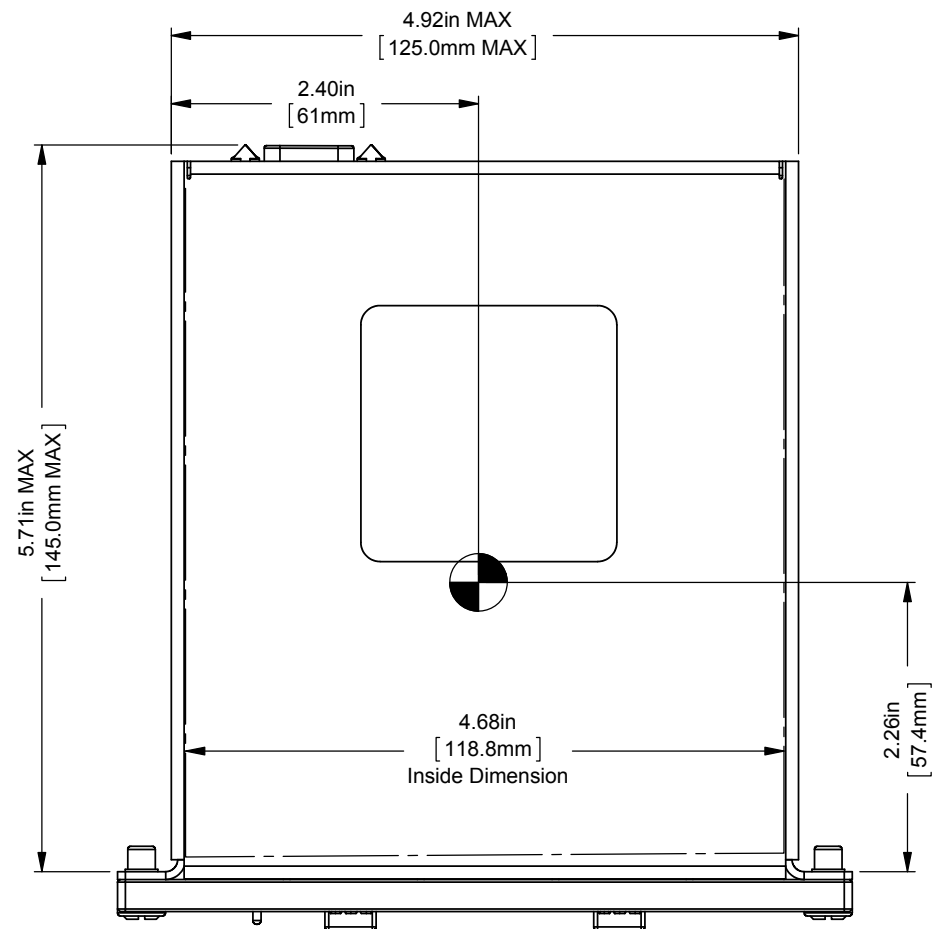

 **CENTER OF GRAVITY**
 ±0.03in [0.8mm]
WEIGHT: 1.50 lbs [0.68 kg] MAX.

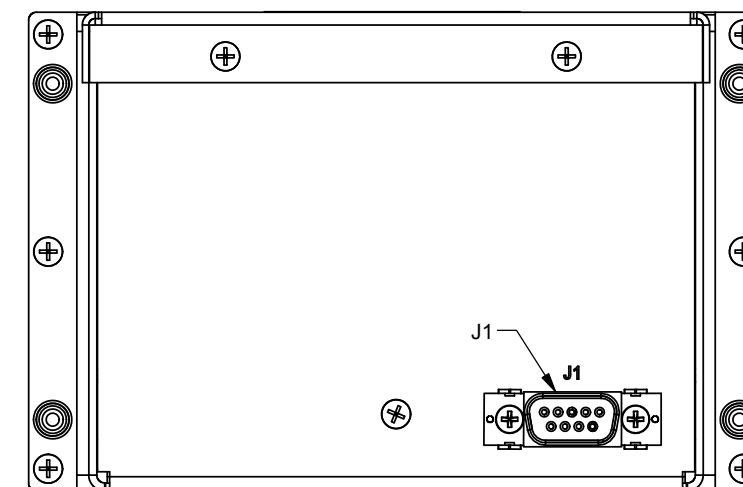
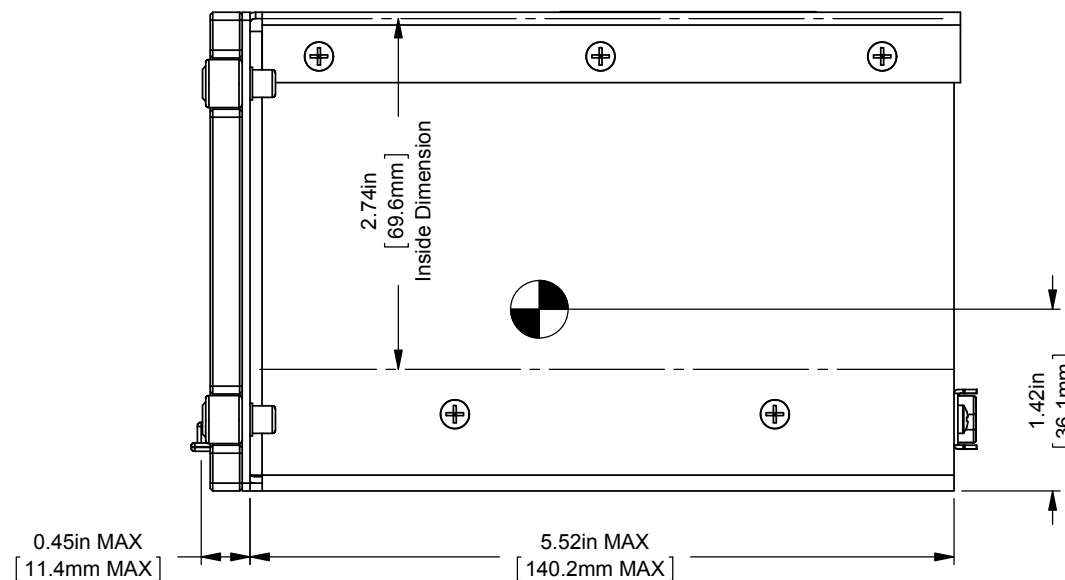
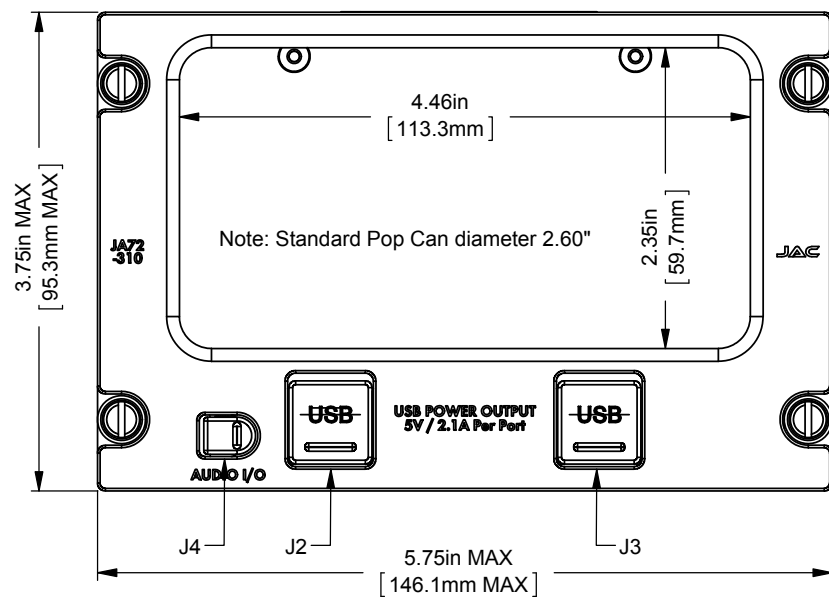
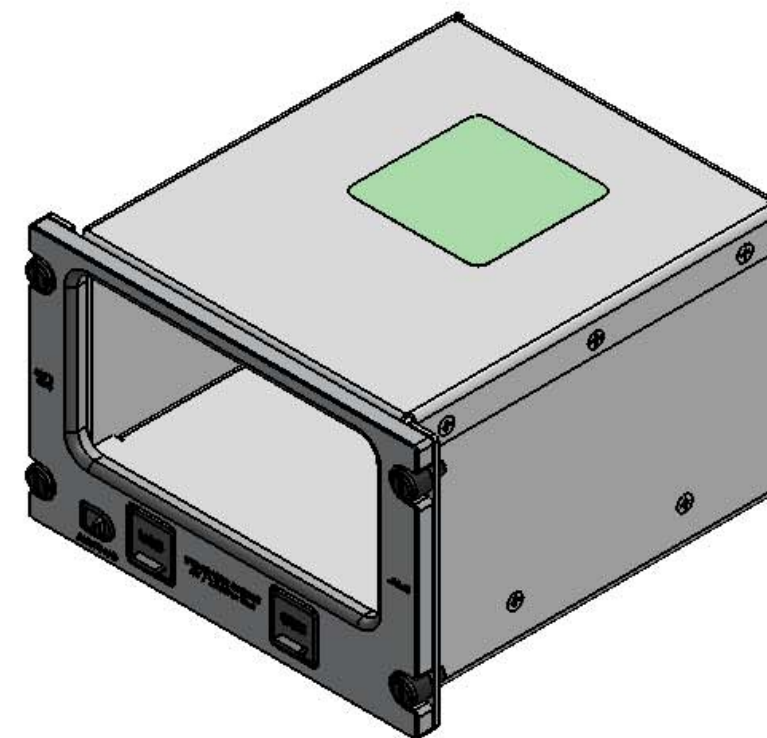

UNLESS OTHERWISE SPECIFIED
 DIMENSIONS ARE IN INCHES
 ANGLES ARE IN DEGREES
 TOLERANCES:
 1 DEC PLACE: ± 0.1
 2 DEC PLACE: ± 0.01
 3 DEC PLACE: ± 0.005
 ANGLES: ± 0.5 DEG

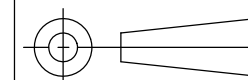

MATERIAL: N/A
 FINISH: N/A

PREPARED
 CHECKED
 APPROVED
 CONFIDENTIAL & PROPRIETARY
 TO JUPITER AVIONICS CORP.
 DRAWING NOT TO SCALE

		TITLE Glove Box with Dual USB Charger and Audio Jack - 10 Dzus	
		NCAGE CODE L00N3	PART NO. JA72-310
DOC. NO. JA72-310 Mechanical Installation Rev A.SLDDRW			

Installation and Operating Manual

Appendix B - Installation Documents



B1 **Airworthiness**

Airworthiness approval of the JA72-310 may require completion of a TCCA Major Modification Report per CAR STD (AWM) 571 Appendix L, or a FAA Form 337. The sample wording for a description of the work is provided to assist the Installing Agency in preparing Instructions for Continued Airworthiness (ICA) when installing a Jupiter Avionics JA72-310 Glove Box with Dual USB Charger and Audio Jack - 10 Dzus. This sample may be modified appropriately for new installations. It is the installer's responsibility to determine the applicability of the method used. Installations performed outside Canada must follow the applicable aviation authority's regulations.

Sample Wording:

Installed the Jupiter Avionics JA72-310 Glove Box with Dual USB Charger and Audio Jack - 10 Dzus in [aircraft location].

Installed in accordance with the JA72-310 Installation Manual, Revision [], and AC 43.13-2, Chapters 2, and 3.

The JA72-310 Installation Manual provides detailed installation instructions and wiring diagrams (Section 2, and Appendices A and B).

Power is supplied to the JA72-310 through a 2-Amp circuit breaker.

Aircraft equipment list, weights and balance amended. Compass compensation checked and found to conform to applicable regulations.

B2 **Instructions for Continued Airworthiness**

Maintenance of the JA72-310 Glove Box with Dual USB Charger and Audio Jack - 10 Dzus is "on condition" only. Refer to the JA72-310 Maintenance Manual. Periodic maintenance of the JA72-310 is not required.

The following sample Instructions for Continued Airworthiness (ICA) provides assistance in preparing ICA for the Jupiter Avionics JA72-310 unit installation as part of a Type Certificate (TC) or Supplemental Type Certificate (STC) project to comply with CAR STD (AWM) 523/527/525/529.1529 or FAR 23/25/27/29.1529 "Instructions for Continued Airworthiness".

Items that may vary by aircraft make and model are shown in brackets ("[]") and should be filled in as appropriate. Some of the checklist items do not apply, in which case they should be marked "N/A" (Not Applicable).

Instructions for Continued Airworthiness, Jupiter Avionics JA72-310 Glove Box with Dual USB Charger and Audio Jack - 10 Dzus in an [Aircraft Make and Model]

1. Introduction

[Aircraft that has been altered: Registration number, Make, Model and Serial Number]

Content, Scope, Purpose and Arrangement: This document identifies the Instructions for Continued Airworthiness for a Jupiter Avionics JA72-310 installed in an [aircraft make and model].

Applicability: Applies to a Jupiter Avionics JA72-310 installed in an [aircraft make and model].

Definitions/Abbreviations: None, N/A.

Precautions: None, N/A.

Units of Measurement: None, N/A.

Referenced Publications: JA72-310 Installation and Operating Manual

JA72-310 Maintenance Manual

STC/TC # [applicable STC/TC number for the specific aircraft installation]

Distribution: This document should be a permanent aircraft record.



2. Description of the System/Alteration

Jupiter Avionics JA72-310 Glove Box with Dual USB Charger and Audio Jack - 10 Dzus. Refer to Appendix A of this manual for interconnect information. Refer to aircraft manufacturer approved interconnect for actual installation.

3. Control, Operation Information

Refer to section 3 of this manual.

4. Servicing Information

N/A

5. Maintenance Instructions

Maintenance of the JA72-310 is 'on condition' only. Periodic maintenance is not required. Refer to the JA72-310 Maintenance Manual.

6. Troubleshooting Information

Refer to the JA72-310 Maintenance Manual.

7. Removal and Replacement Information

Refer to Section 2 of this manual - the JA72-310 Installation and Operating Manual. If the unit is removed and reinstalled, a functional check of the equipment should be conducted.

8. Diagrams

Refer to Appendix A of this manual - the JA72-310 Installation and Operating Manual - for installation drawings and interconnect examples.

9. Special Inspection Requirements

N/A

10. Application of Protective Treatments

N/A

11. Data: Relative to Structural Fasteners

JA72-310 and appropriate mounting hardware installation, removal and replacement should be in accordance with applicable provisions of AC 43.13-1B and AC 43.13-2A.

12. Special Tools

N/A

13. This Section is for Commuter Category Aircraft Only

A. **Electrical loads:** Refer to Section 1 of the JA72-310 Installation and Operating Manual.

B. **Methods of balancing flight controls:** N/A.

C. **Identification of primary and secondary structures:** N/A.

D. **Special repair methods applicable to the airplane:** N/A.

14. Overhaul Period

No additional overhaul time limitations.

15. Airworthiness Limitation Section

N/A